

TEST REPORT | *Rapporto di Prova N°*

DATE OF TEST | *Data della prova*

TH_Report206

12/02/2021

TEST TYPE | *Tipologia prova*

Dynamic impact test T.H.O.R.

TEST ITEM | *Tipologia dispositivo*

C 125x62,5x25x5 post
L=1650-2050 mm



CLIENT | *Committente*

SAFEROAD RRS GmbH

NUMBER OF PAGES | *Numero di pagine*

20

OFFICIAL LANGUAGE | *Lingua ufficiale*

English

Laboratory Responsible | *Responsabile del laboratorio*
Eng. Alfredo Cocco

Scientific Director | *Direttore Scientifico*
Eng. Stefano Frascchetti



T.H.O.R.
TESTING HEAD OVER ROAD

DATE OF REPORT | *Data report* **CONTRACT** | *N. commessa*

AISICO TEST HOUSE

26/02/2021

A061_21

INDEX

1	PREMISE	4
2	TEST LABORATORY	4
3	CUSTOMER	5
4	TEST ITEM	5
5	TEST EQUIPMENT AND PROCEDURE	6
6	IMPACT TESTS	8
6.1	Impact test TH513.....	13
6.2	Impact test TH512.....	16
7	GENERALS	19
8	TEST REPORT APPROVAL	20

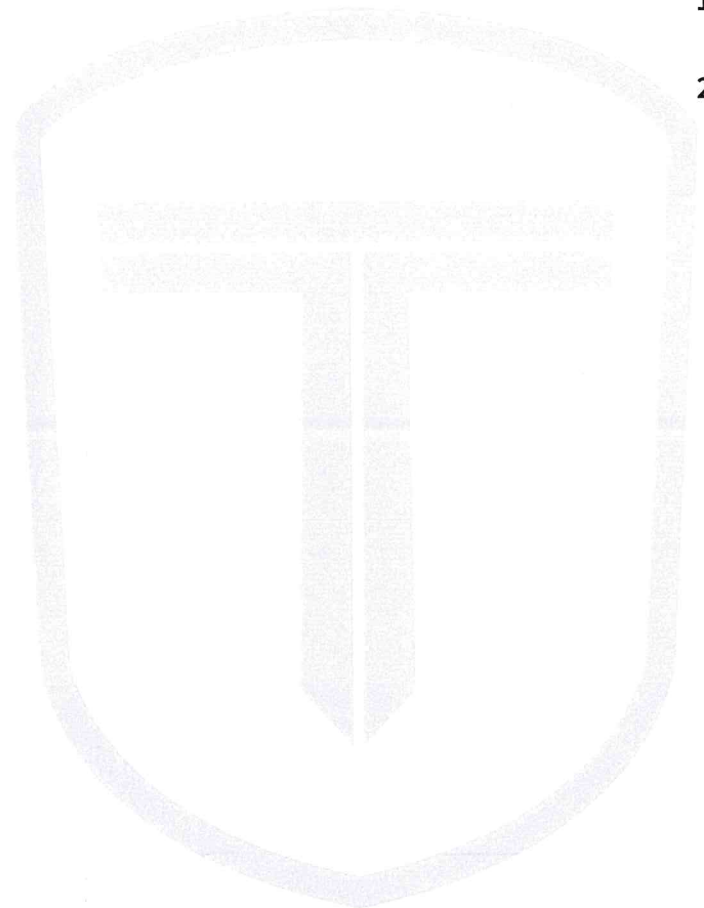

TH_Report206

FIGURES INDEX

Figure 1: Testing Head Over Road	6
Figure 2: Test structure's testing head	7
Figure 3: T.H.O.R. – Test configuration	7
Figure 4: Quantities to be detected	10
Figure 5: C post 125x62,5x25 mm, 1650 length and 5 mm thickness technical drawing.....	11
Figure 6: C post 125x62,5x25 mm, 2050 length and 5 mm thickness technical drawing.....	12
Figure 7: TH513 - Test configurations	15
Figure 8: TH513 - Post-crash configurations.....	15
Figure 9: TH512 - Test configurations	18
Figure 10: TH512 - Post-crash configurations	18

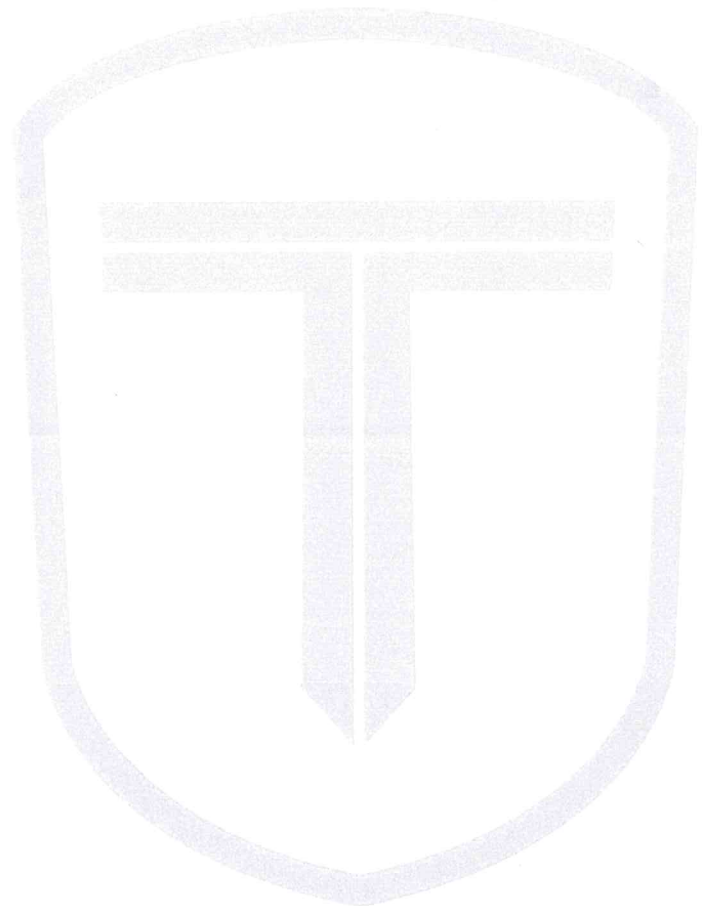

TH_Report206

1 PREMISE

This document is prepared in order to report the results of dynamic impact tests on the posts of the road safety device subject to crash tests #1901 – 1905, model SafeStar 221, according to different test configurations.

2 TEST LABORATORY

TEST LABORATORY	
NAME	AISICO S.r.L.
ADDRESS	Viale Bruno Buozzi 47, 00197 Roma, Italy
PHONE NUMBER	+39 06 32110436
FAX	+39 06 32502282
E-MAIL	centroprove@aisico.it
WEB SITE	www.aisico.it

AISICO TEST HOUSE	
ADDRESS	SP27 del Cavaliere, Località Salone km 2+500 67064 PERETO (AQ)
PHONE NUMBER	+39 0863 1827288
FAX	+39 0863 1827289

TH_Report206

3 CUSTOMER

PARTICULARS	
NAME	SAFEROAD RRS GmbH
ADDRESS	Tauentzienstraße 4 10789 Berlin - Berlin Germany
E-MAIL	marcus.krueger@saferoad-rrs.de
WEB SITE	www.saferoad.com

4 TEST ITEM

TEST DEVICE POST 125x62,5x25mm th = 5 mm	
INSTALLED TEST DEVICE	Post C 125x62,5x25mm th=5 mm, L=1650-2050 mm
REPORT DATE	12/02/2021
TEST NUMBER	TH512, TH513

TH_Report206**5 TEST EQUIPMENT AND PROCEDURE**

The impact tests on the examined samples have been performed using the moving equipment T.H.O.R. – Testing Head Over Road (Image 1).

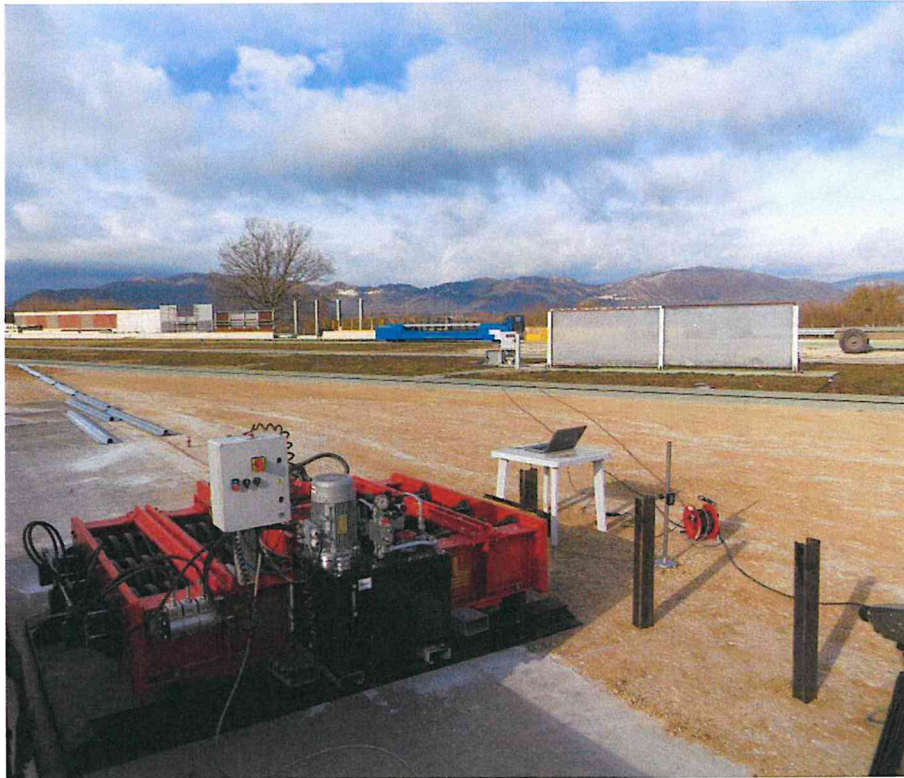

Figure 1: Testing Head Over Road

The test structure is based on the transformation of the elastic potential energy released by the compression of the springs, of which it is composed, into kinetic energy and therefore, in part, also into the impact energy of the hammer, with which it is equipped.

The equipment consists of an impact head of known weight which runs through small wheels on linear guides. Its speed, and therefore its energy, is provided by a series of parallel springs, whose elastic constant is known. The springs are compressed and released and this movement pushes the impact head horizontally in a straight motion.

The springs are positioned around tubes arranged in the same direction of movement as the hammer and are rigidly connected to the machine structure. The hydraulic loading cylinders are inserted inside them. Through a special bracket connected to the stem, the hydraulic system is able to simultaneously compress the head and springs.

TH_Report206



Figure 2: Test structure's testing head

During the impact, the test variables are measured and the phenomenon is recorded by a high-speed camera and a laser system.



Figure 3: T.H.O.R. – Test configuration

TH_Report206

6 IMPACT TESTS

The samples on which the impact tests have been carried out are type C posts of the H2 metal barrier for ground model SafeStar 221, sect. 125x62.5x25 mm thick 5 mm. The tests were performed at the AISICO srl test house in two different configurations, described in the following paragraphs and named as follows:

- TH513: standard post, 1650 mm length driven for 800 mm in flat and well compacted ground, consisting of calcareous gravel in a silty sandy matrix of classification A-1-a according to UNI EN ISO 14688-2: 2018 (crash test conditions);
- TH512: post with increased length, 2050 mm, driven for 1200 mm in flat and well compacted soil, consisting of calcareous gravel in a silty sandy matrix of classification A-1-a according to the UNI EN ISO 14688-2: 2018 standards.

The dynamic tests were carried out according to the following test methods:

TEST CONFIGURATION TH513	
Test configuration	C Post 125x62,5x25x5 mm L=1650 mm Crash test conditions
Mass of the head [kg]	450
Effective speed of impact [m/s]	6,3
Impact energy [kJ]	8,8
Impact point height [cm]	57 ⁽¹⁾
Post driving [cm]	80
Post height [cm]	85 ⁽¹⁾

⁽¹⁾ height defined by the road surface

TEST CONFIGURATION TH512	
Test configuration	C Post 125x62,5x25x5 mm L=2050 mm
Mass of the head [kg]	450
Effective speed of impact [m/s]	6,3
Impact energy [kJ]	8,8
Impact point height [cm]	57 ⁽¹⁾
Post driving [cm]	120
Post height [cm]	85 ⁽¹⁾

⁽¹⁾ height defined by the road surface

In both test configurations, there's a 110x47 U-shaped post reinforcement, 5 mm thickness and 300 mm length, driven into the ground for 100 mm.

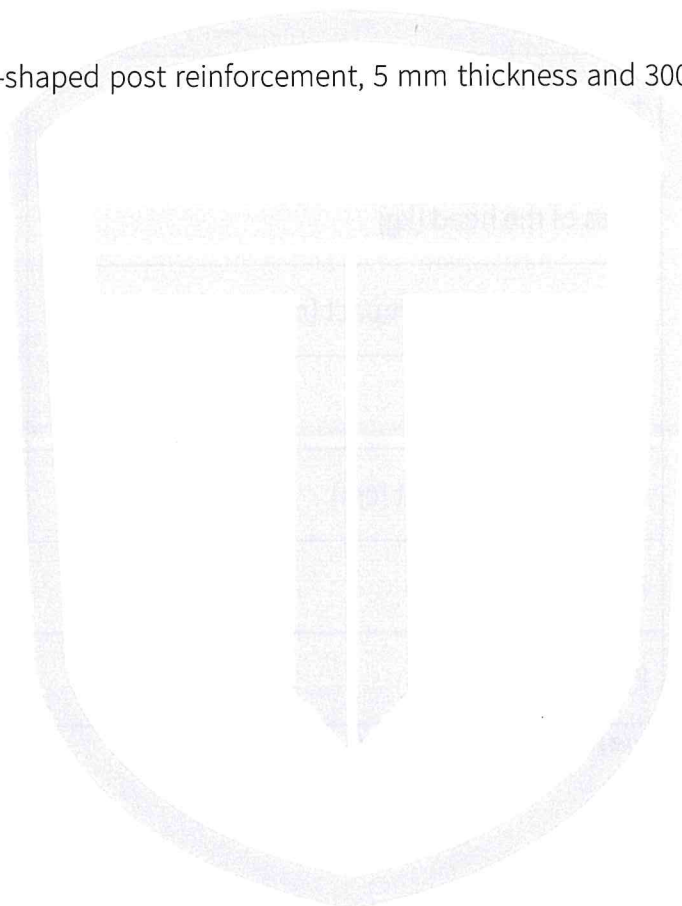

The results of the dynamic tests in the following report are expressed, consistently with what is indicated in the technical document UNI / TR 11785, in terms of:

- displacement - time curve;
- position of the plastic hinge P respect to the base of the pole (at the maximum distance a);
- maximum displacement of the post's head (X_A);
- maximum dynamic deflection at impact point height;
- displacement of the post's base (X_B);
- lowering of the post's head (Y_A);
- contact time in which the post absorbs all the energy originated in the impact;
- capacity of the post to absorb the energy originated in the impact (CE).

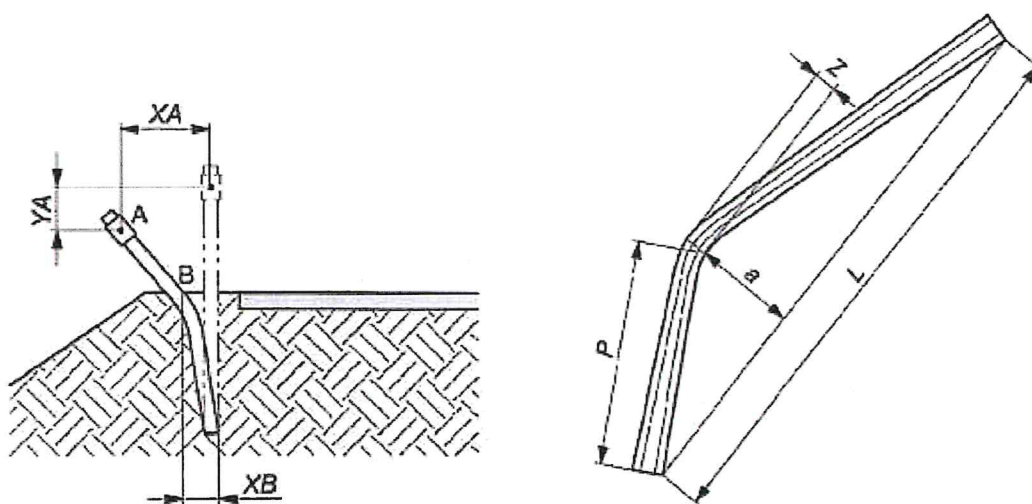

Figure 4: Quantities to be detected

Technical drawings of the two test poles are reported below.

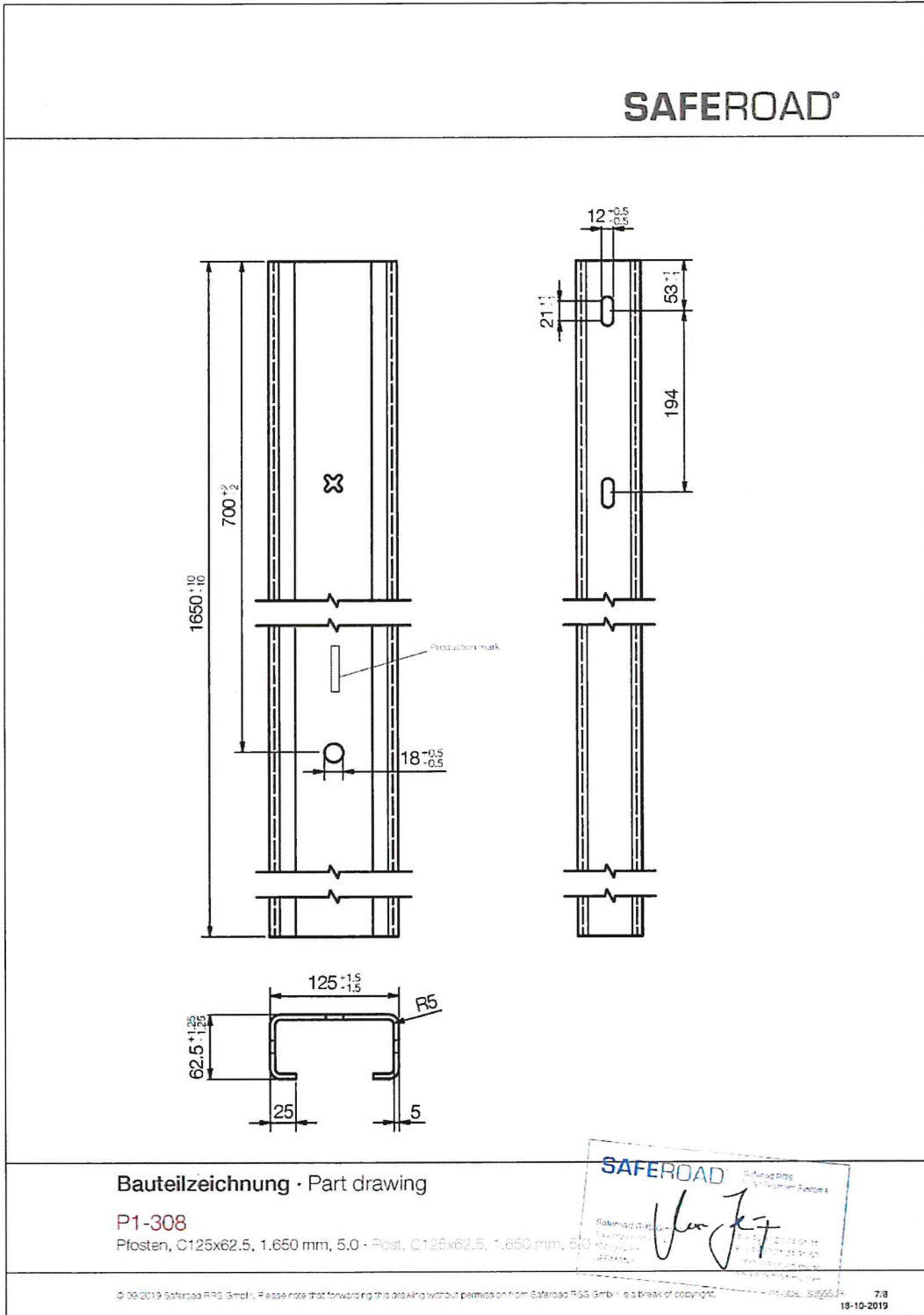

Figure 5: C post 125x62,5x25 mm, 1650 length and 5 mm thickness technical drawing

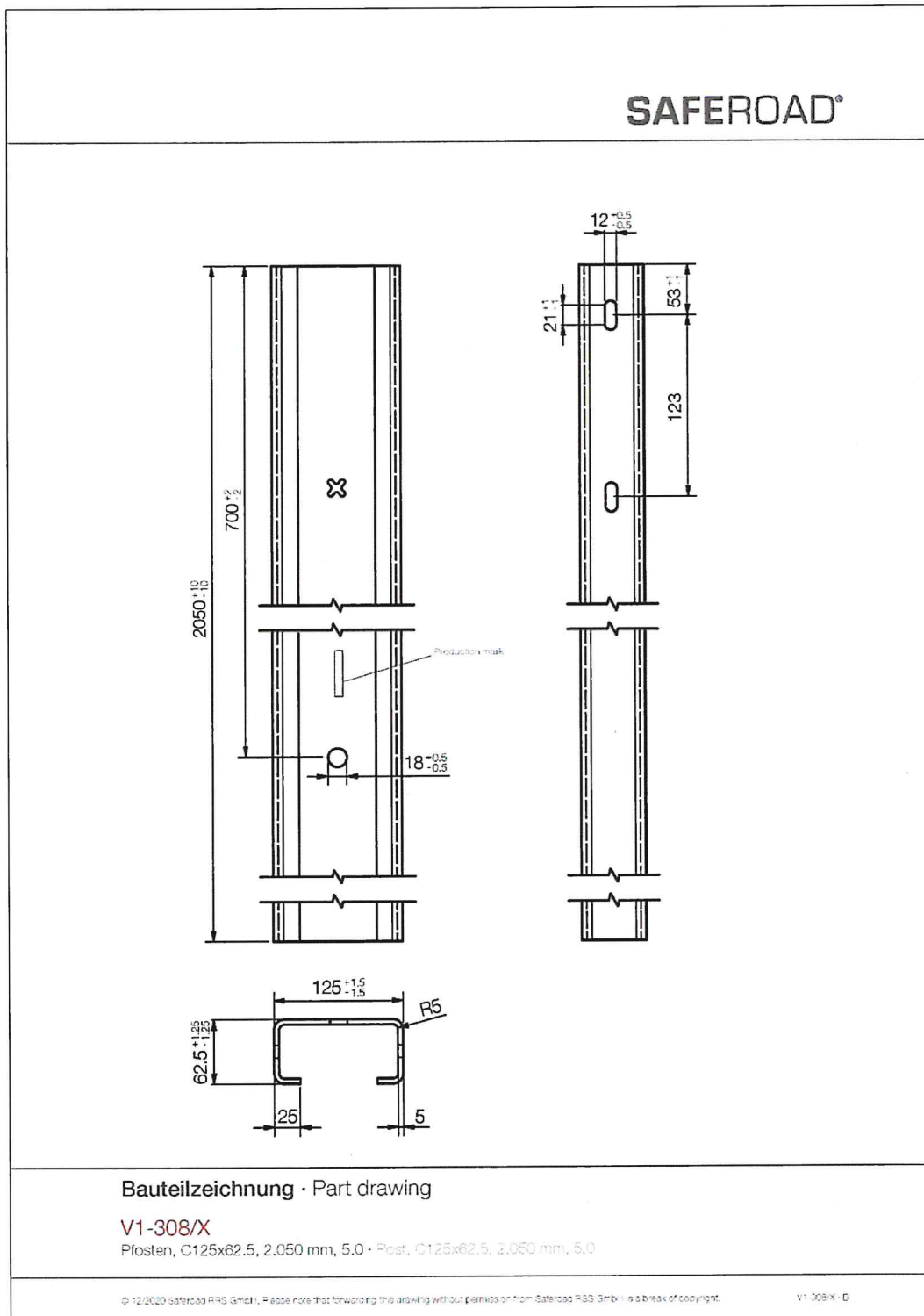

Figure 6: C post 125x62,5x25 mm, 2050 mm length and 5 mm thickness technical drawing

6.1 Impact test TH513



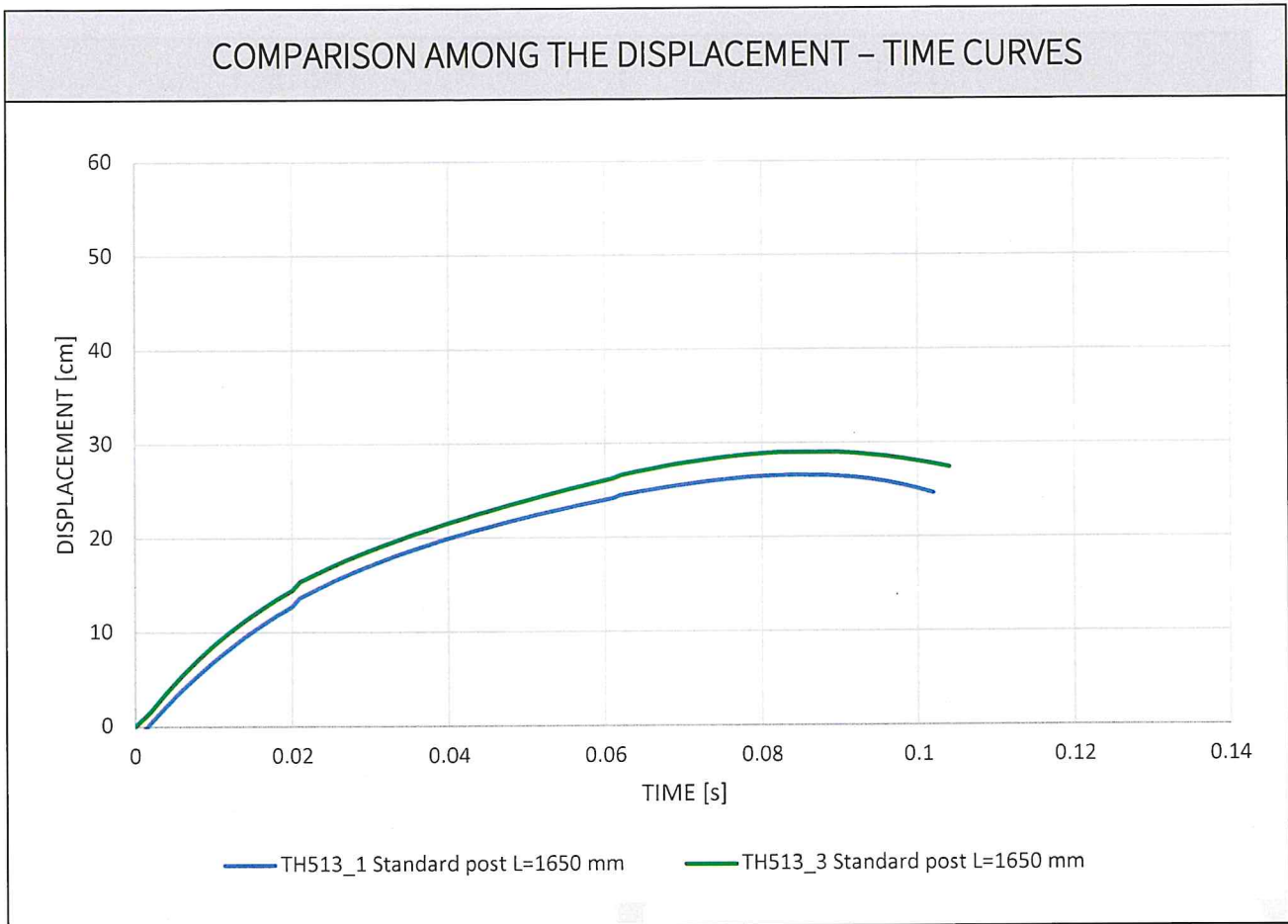

The TH513 impact test was performed on a standard 125x62.5x25x5 mm C-post, 1650 mm length, driven into the ground for 800 mm.

IMPACT TESTS RESULTS		
	TH513_1	TH513_3
Static deflection of the post's head [cm]	30	31
Displacement of the post's base [cm]	4	3
Final height of the post's head [cm]	83	84
Lowering of the post's head [cm]	2	1
Position of the plastic hinge P [cm]	70	67
Maximum dynamic deflection at impact point height [cm]	27	29
Energy absorption time [ms]	86	86
Capacity to absorb the energy $C_{E,A}^{(1)}$	67	61

⁽¹⁾ $C_{E,A}$ = Capacity to absorb the energy, inversely proportional to the area under the displacement-time curve calculated up to the maximum value



RESULTS			
	Average value of maximum dynamic deflection at impact point height [cm]	Average value of energy absorption time [ms]	Average value of capacity to absorb the energy C_{EA}
TH513	28	86	64

TH513_1	TH513_3
	
Figure 7: TH513 - Test configurations	
	
Figure 8: TH513 - Post-crash configurations	

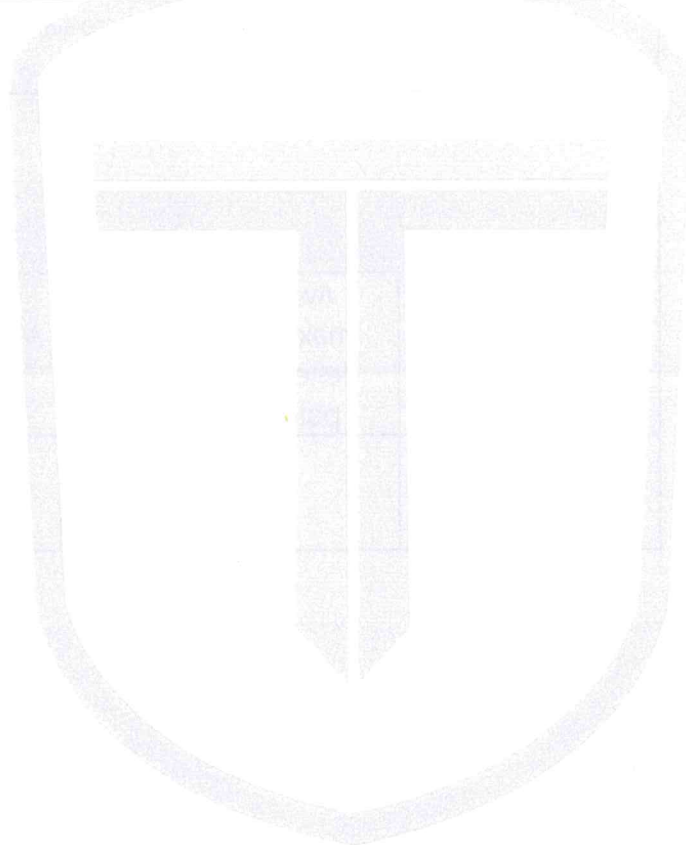

6.2 Impact test TH512

The TH512 impact test was performed on a 125x62.5x25x5 mm C-post, with an increased length, 2050 mm, driven into the ground for 1200 mm.

IMPACT TESTS RESULTS			
	TH512_1	TH512_2	TH512_3
Static deflection of the post's head [cm]	28	27	29
Displacement of the post's base [cm]	2	2	2
Final height of the post's head [cm]	84	84	82
Lowering of the post's head [cm]	1	1	3
Position of the plastic hinge P [cm]	102	105	104
Maximum dynamic deflection at impact point height [cm]	24	24	23
Energy absorption time [ms]	82	84	82
Capacity to absorb the energy C_{EA} ⁽¹⁾	76	76	79

⁽¹⁾ C_{EA} = Capacity to absorb the energy, inversely proportional to the area under the displacement-time curve calculated up to the maximum value

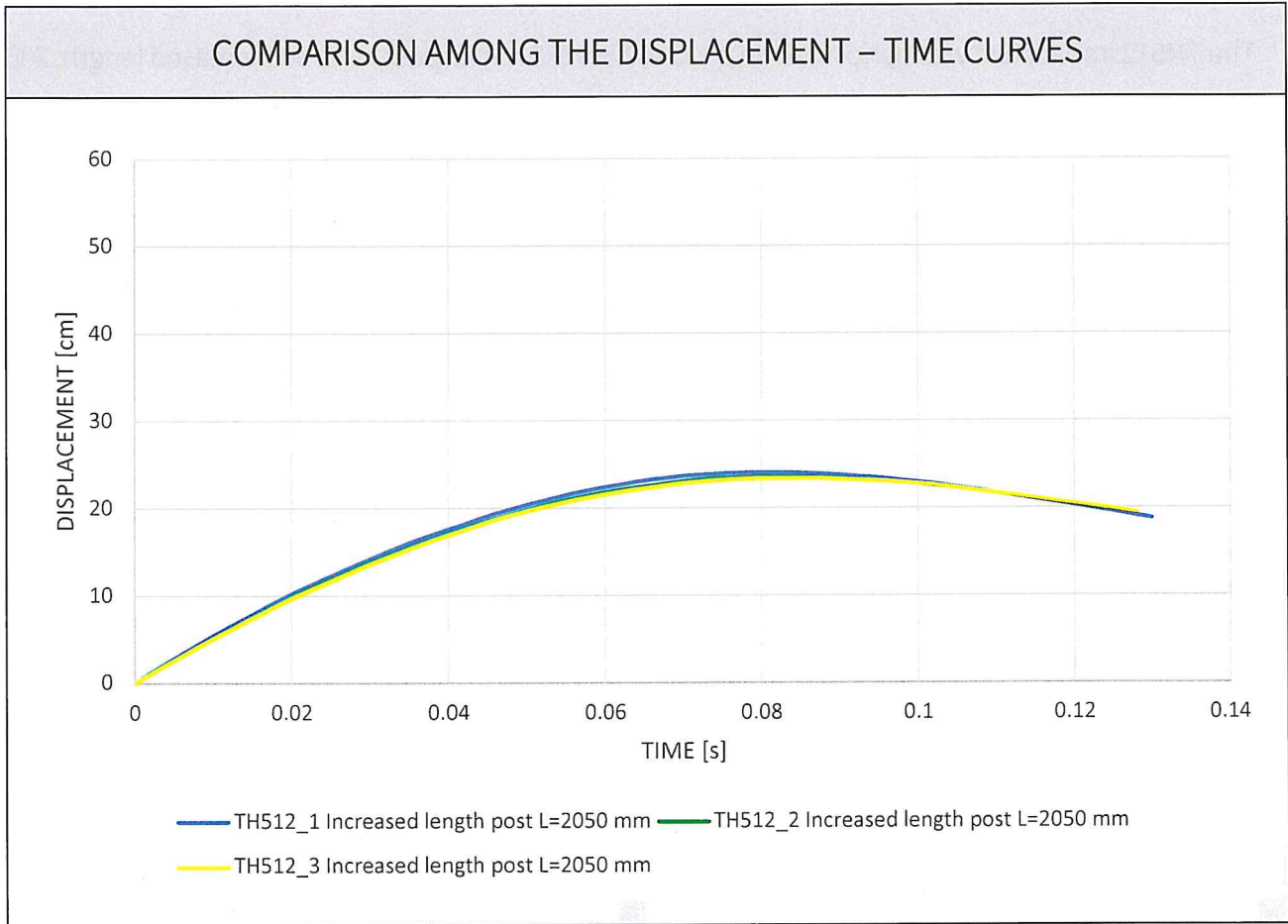

RESULTS			
	Average value of maximum dynamic deflection at impact point height [cm]	Average value of energy absorption time [ms]	Average value of capacity to absorb the energy C_{EA}
TH512	24	83	77



Figure 9: TH512 - Test configurations



Figure 10: TH512 - Post-crash configurations

TH_Report206

7 GENERALS

The test results in this report relate only to the items being tested.

This report may not be reproduced, except in its entirety, except with the written authorization of the laboratory that drafted it.

Corrections to this test report can only be made by drafting a new document which is designated as a "revision" to the test report to which it refers.

Additions to this test report can only be made by means of a new document which is designated as a "supplement" to the test report to which it refers.

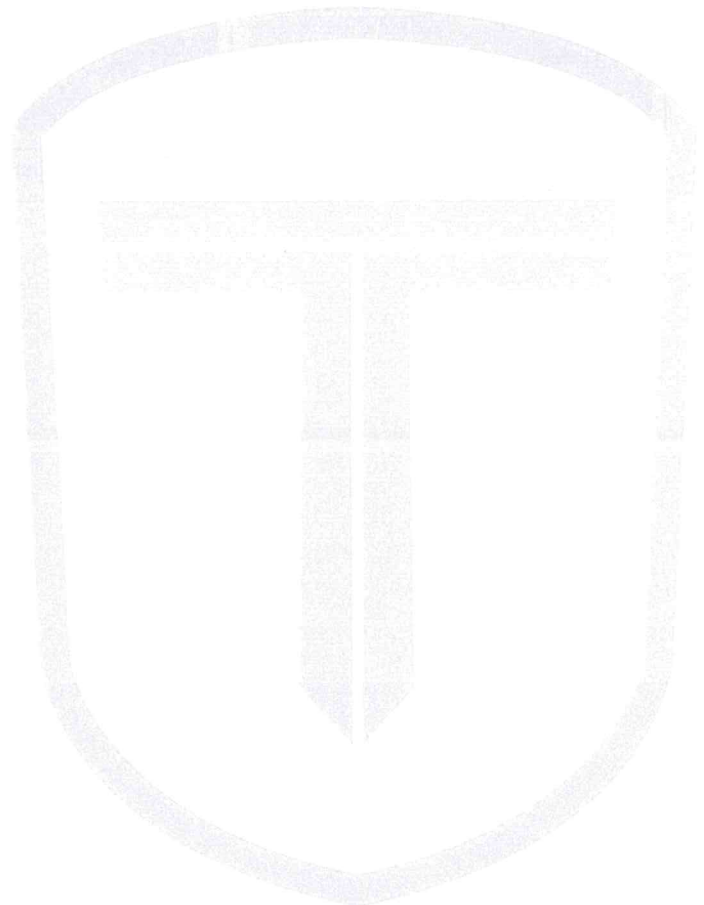

8 TEST REPORT APPROVAL

TEST RESPONSIBLE	
NAME	SIGNATURE
Ing. Alfredo Cocco	

TESTING RESPONSIBLE ENGINEERS		
NAME	COMPETENCE	SIGNATURE
Ing. Stefano Frascchetti	Test scientific data processing and report editing responsible	

Pereto, 26/02/2021

